

VALVE COVERS

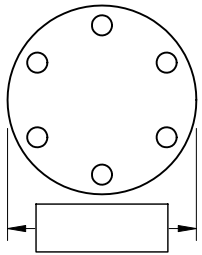

ROUND

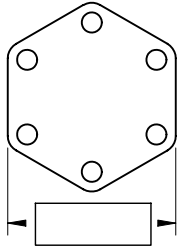

HEX

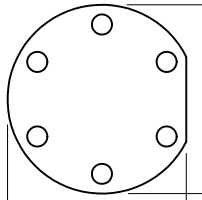

DIA.

FLATS
QTY:

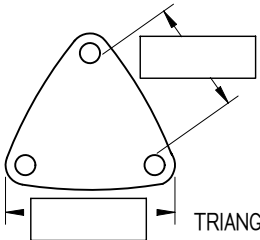

TRIANGULAR

OTHER

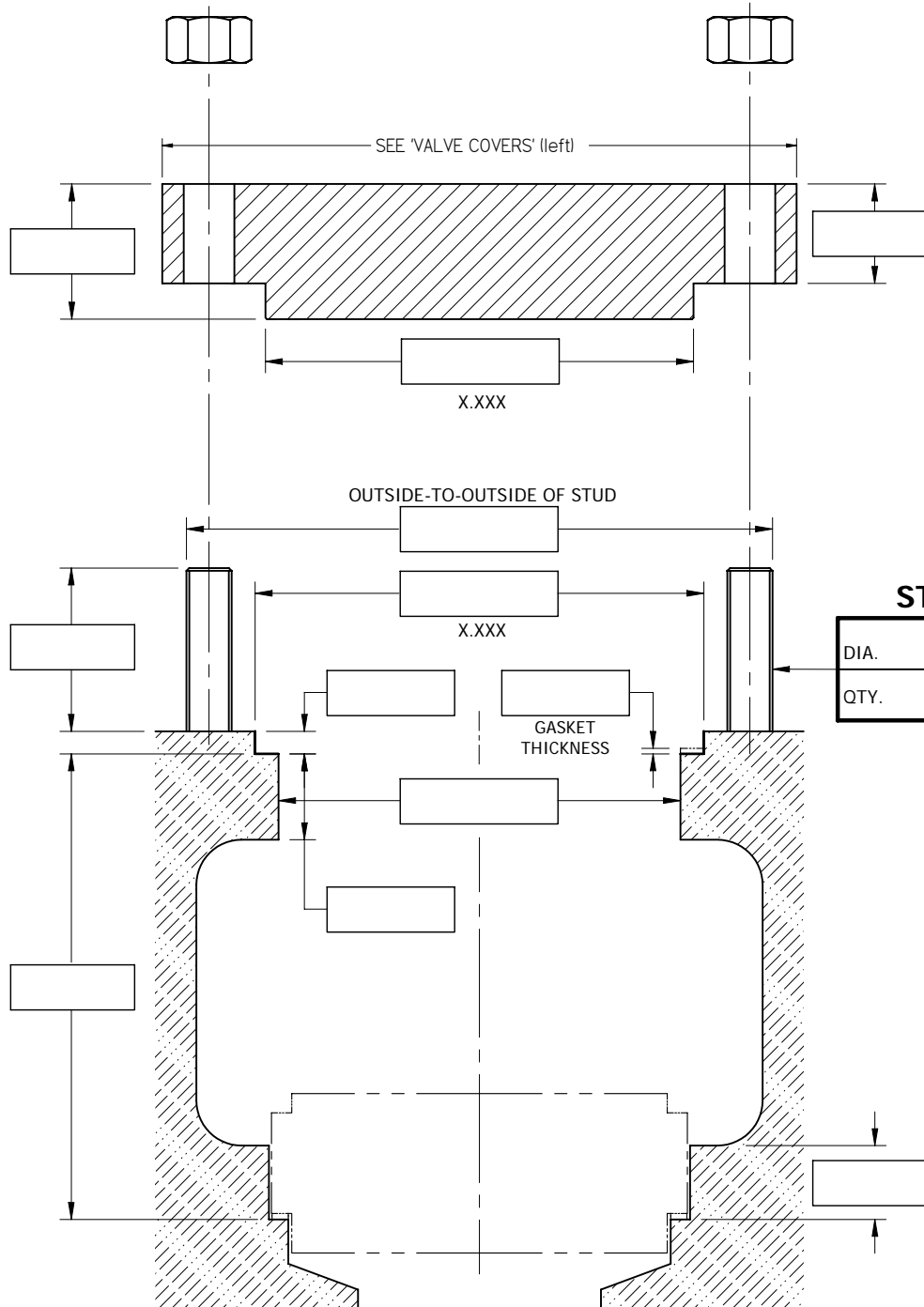

STUDS

DIA.
QTY.

CAGE

IF SAMPLE IS NOT PICTURED,
SKETCH ON REVERSE SIDE

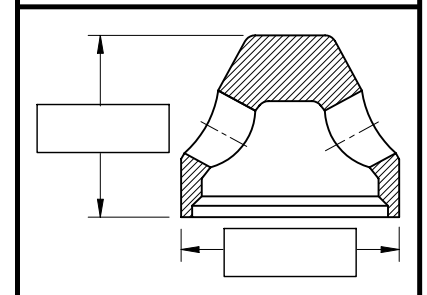
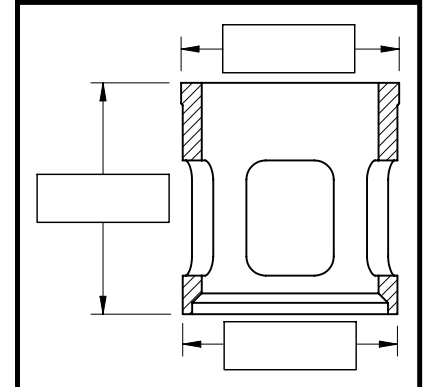

CYLINDER DATA



STYLE A

FLAT GASKET SEAL ON COVER

P:\ENGINEERING\EXCHANGE\LYNN\POCKET DIM DRAWINGS\STYLE A

VALVE COVERS

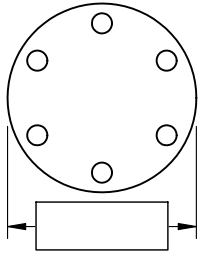

ROUND

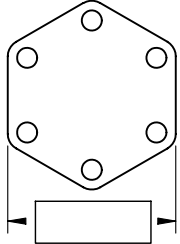

HEX

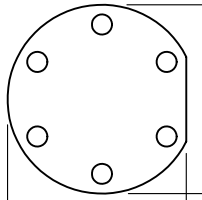

DIA.

FLATS
QTY:

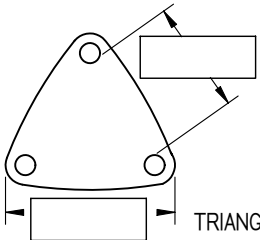

TRIANGULAR

OTHER

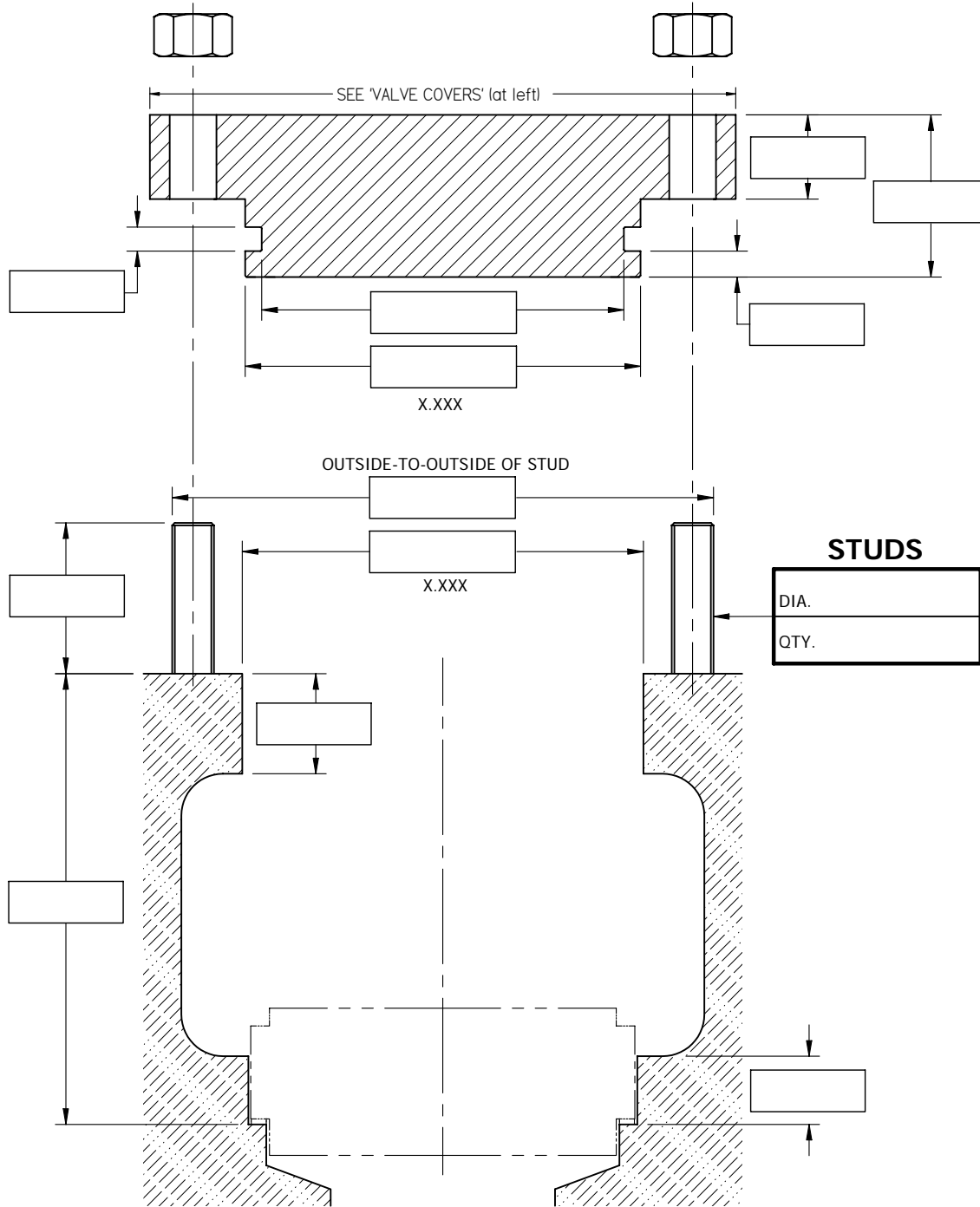

CYLINDER DATA

STUDS

DIA.
QTY.

CAGE

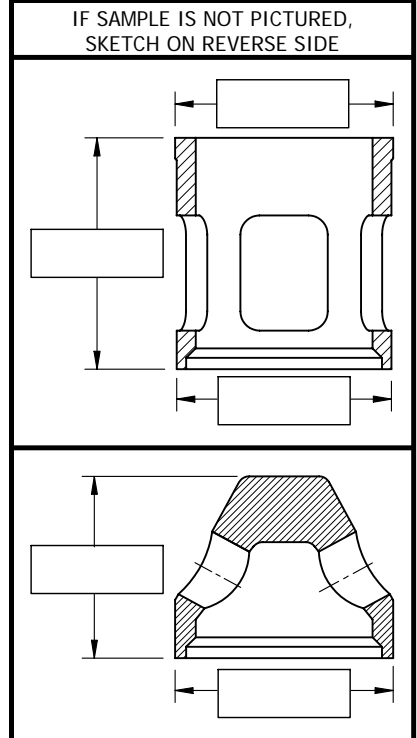

PI\ENGINEERING\EXCHANGE\TMM\POCKET DIM DRAWINGS\STYLE B



STYLE B

'O' RING SEAL ON COVER

VALVE COVERS

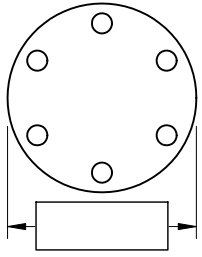

ROUND

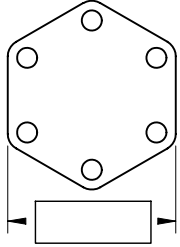

HEX

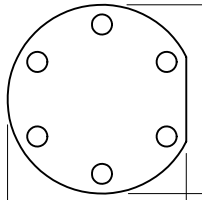

DIA.

FLATS
QTY:

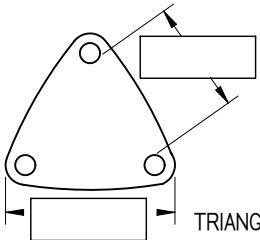

TRIANGULAR

OTHER

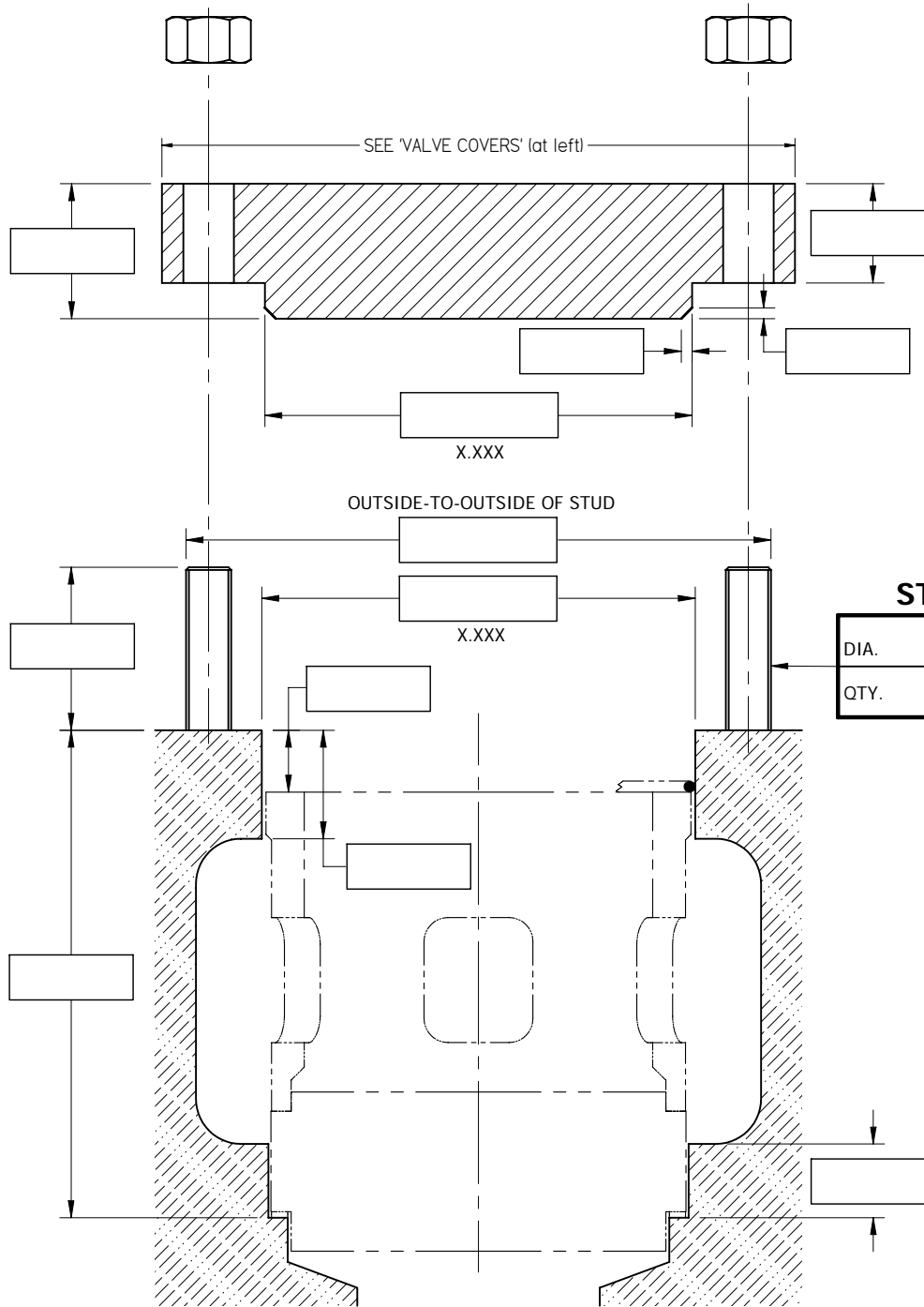

STUDS

DIA.

QTY.

CAGE

IF SAMPLE IS NOT PICTURED,
SKETCH ON REVERSE SIDE

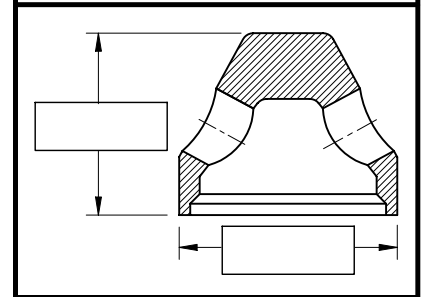
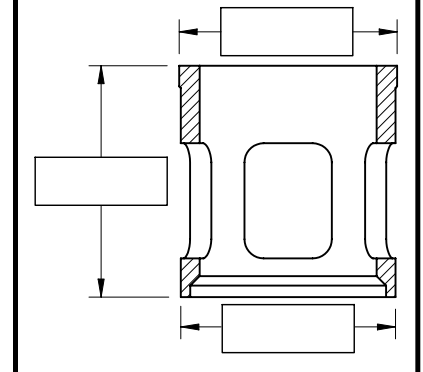

CYLINDER DATA



STYLE C

ROUND WIRE SEAL ON COVER

VALVE COVERS

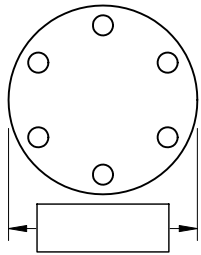

ROUND

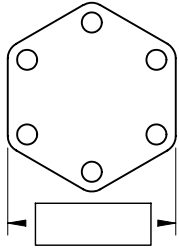

HEX

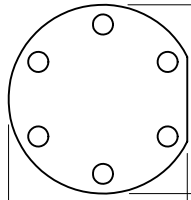

DIA.

FLATS
QTY:

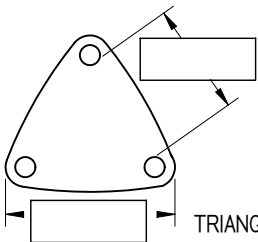

TRIANGULAR

OTHER

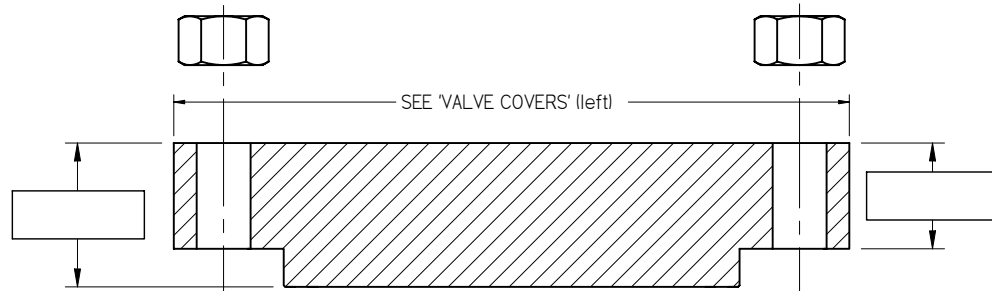

X.XXX

OUTSIDE-TO-OUTSIDE OF STUD

X.XXX

STUDS

DIA.

QTY.

GASKET
THICKNESS

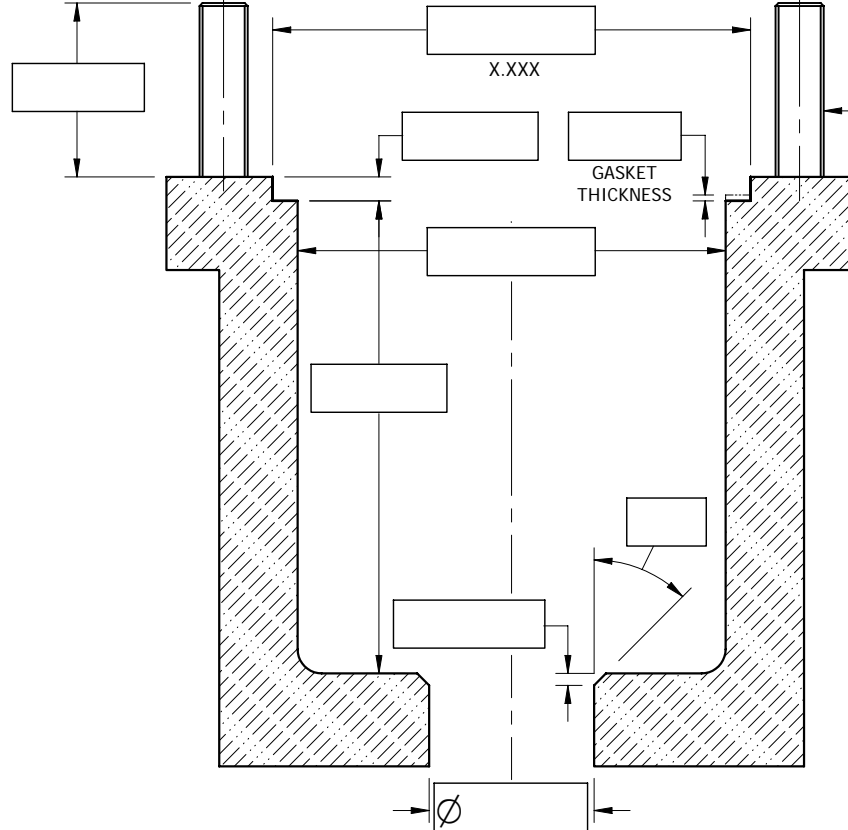

CYLINDER DATA

P:\ENGINEERING\EXCHANGE\LYNN\POCKET DIM DRAWINGS\HE-STYLE A



HE-STYLE A

FLAT GASKET SEAL ON COVER

VALVE COVERS

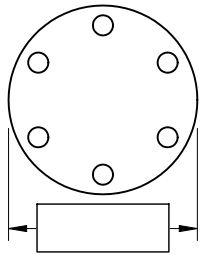

ROUND

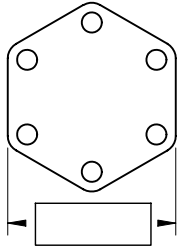

HEX

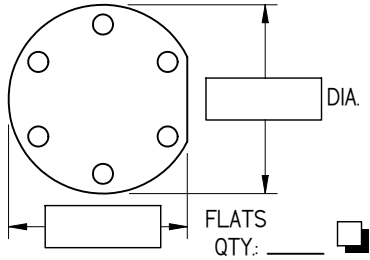

FLATS
QTY.:

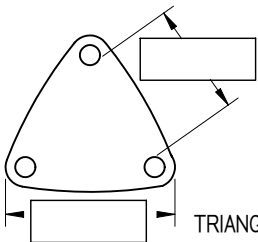

TRIANGULAR

OTHER

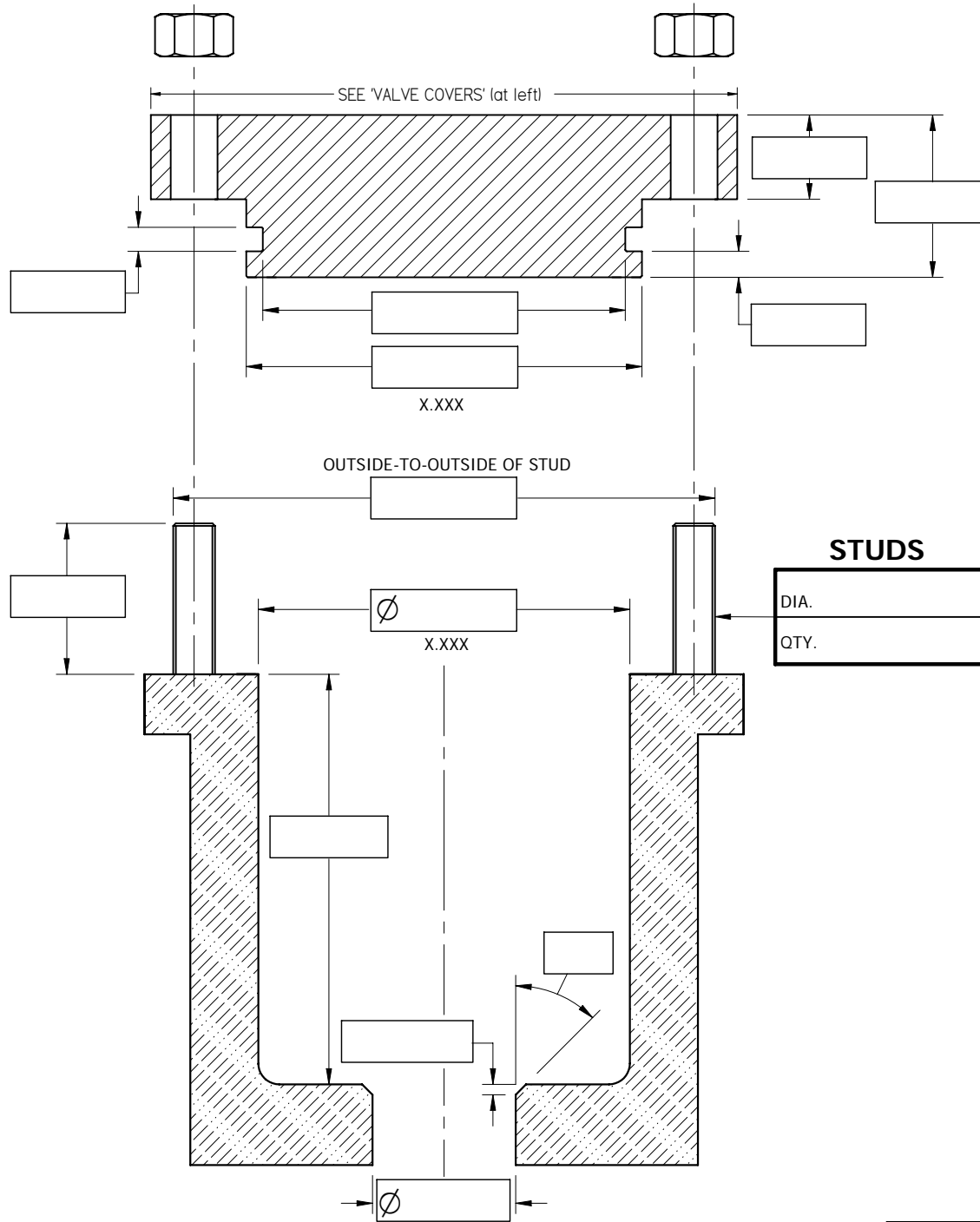

STUDS

DIA.
QTY.

CYLINDER DATA

P:\ENGINEERING\EXCHANGE\LYNN\POCKET DIM DRAWINGS\HE-STYLE B



HE-STYLE B

O-RING SEAL ON COVER

VALVE COVERS

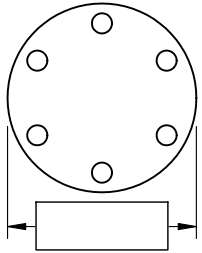

ROUND

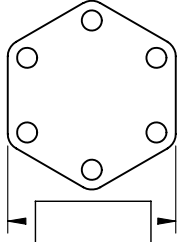

HEX

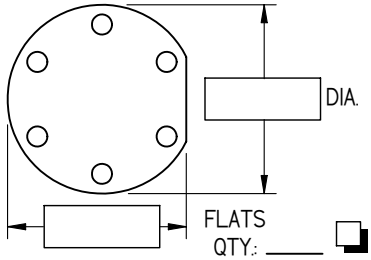

FLATS QTY:

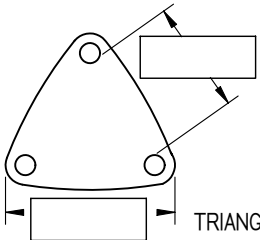

TRIANGULAR

OTHER

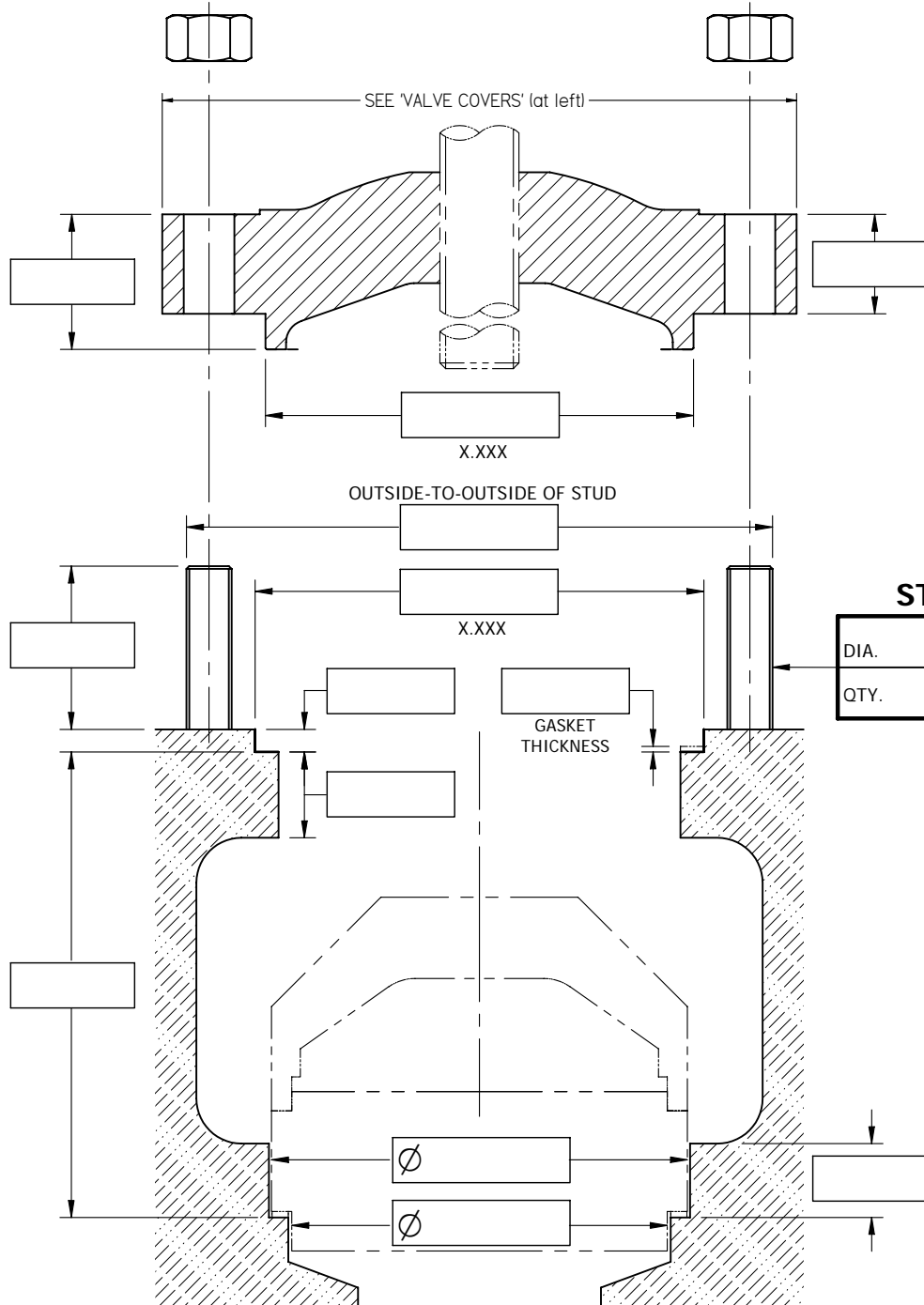

SUCTION PRESSURE

DISCHARGE PRESSURE

STUDS

DIA.

QTY.

CAGE

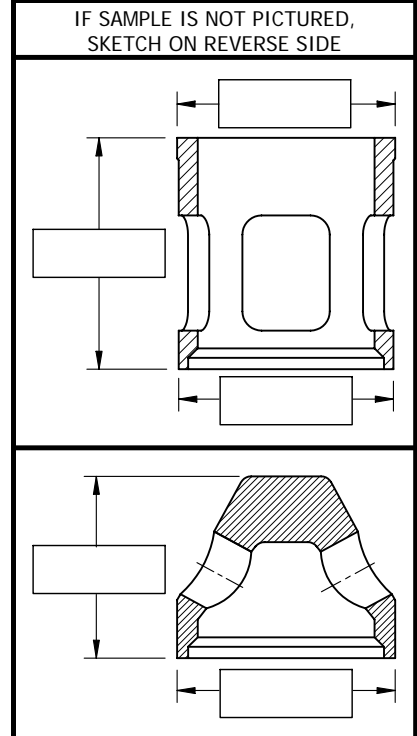

CYLINDER DATA



HSR
HIGH-SECURITY VALVE RESTRAINT